

**Features:**

- ◆ Equivalent to:MACP-011014
- ◆ Surface mount and available in tape and reel
- ◆ 260°C reflow compatible
- ◆ RoHS Compliant and Pb free
- ◆ Operating temperature range: -40°C to +85°C
- ◆ Storage temperature range: -55°C to +100°C

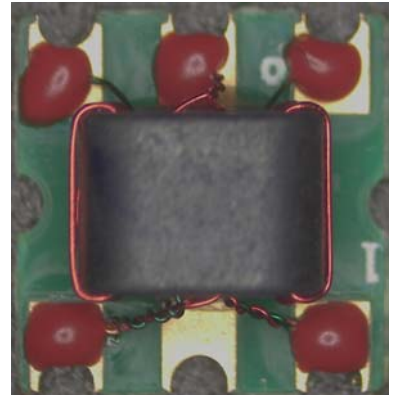

**Applications:**

- ◆ For catv
- ◆ For broadband and wireless communications

**Dimension diagram (Unit:mm) :**

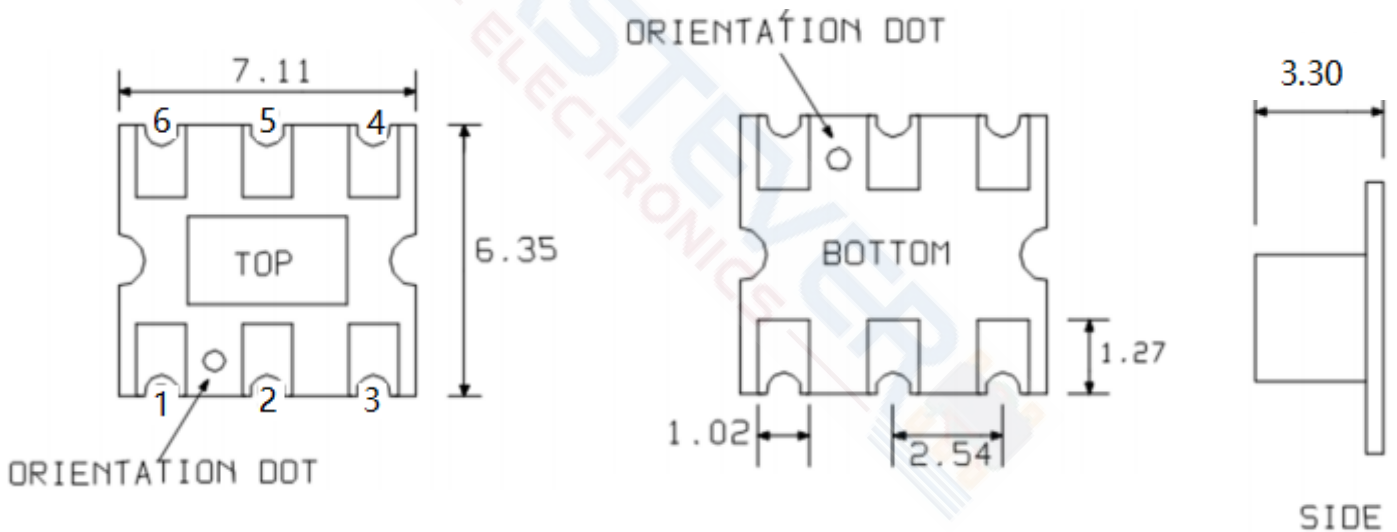

**Electrical structure:**

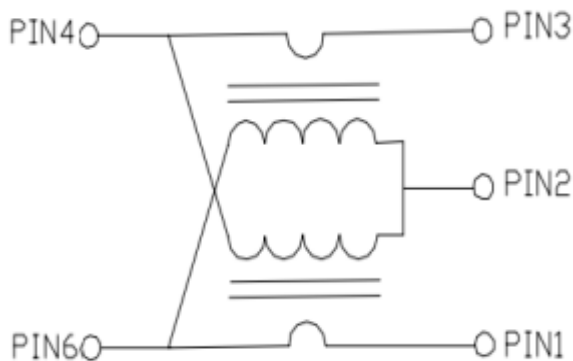

**Recommended layout(mm):**

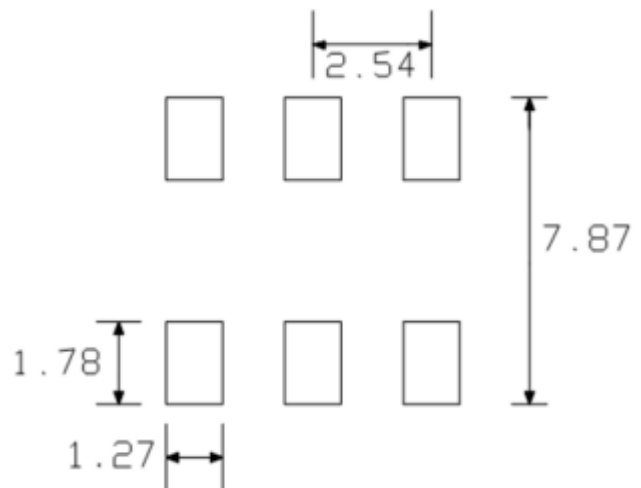

Pin configuration:

Pin no.	Function
1	Input
2	Ground
3	Coupled
4	Isolated
6	Output

Application circuit :

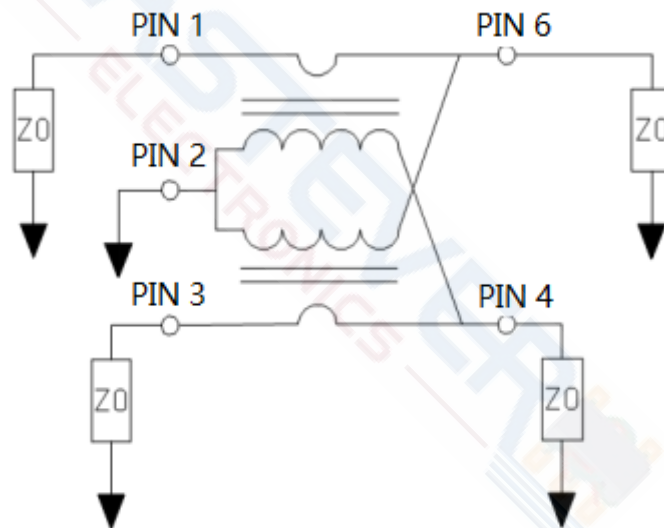

Electrical Specifications:  $T_A=25^{\circ}\text{C}$   $Z_0=75\Omega$

Parameter	Test Conditions	Units	Min	Typ	Max
Main line Loss	5-1250MHz	dB	—	0.5	1.5
Coupling	5-1250MHz	dB	16.3	17.3	18.3
Input Return Loss	5-1250MHz	dB	18.0	30.0	—
Output Return Loss	5-1250MHz	dB	16.0	25.0	—
Coupling Return Loss	5-1250MHz	dB	18.0	25.0	—
Isolation	5-1250MHz	dB	30.0	45.0	—

Main line Loss(pin1-6):

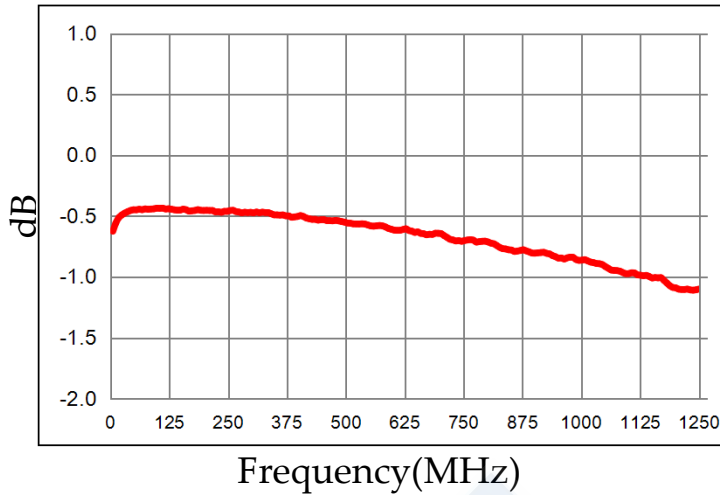

Coupling(pin1-3):

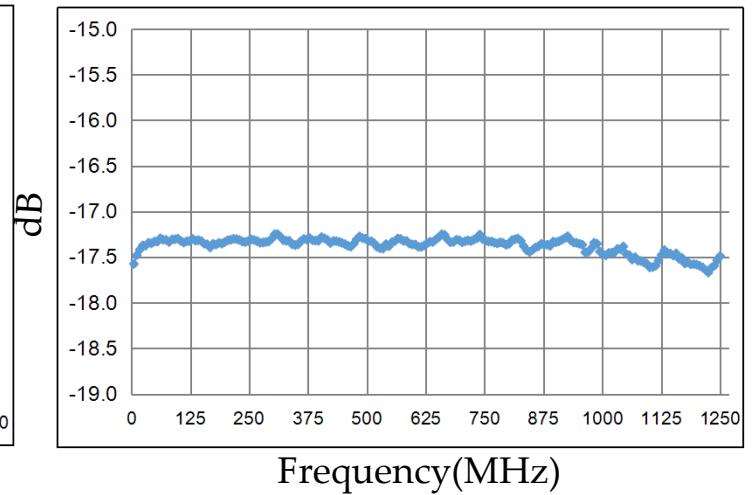

Input Return Loss (Pin1)

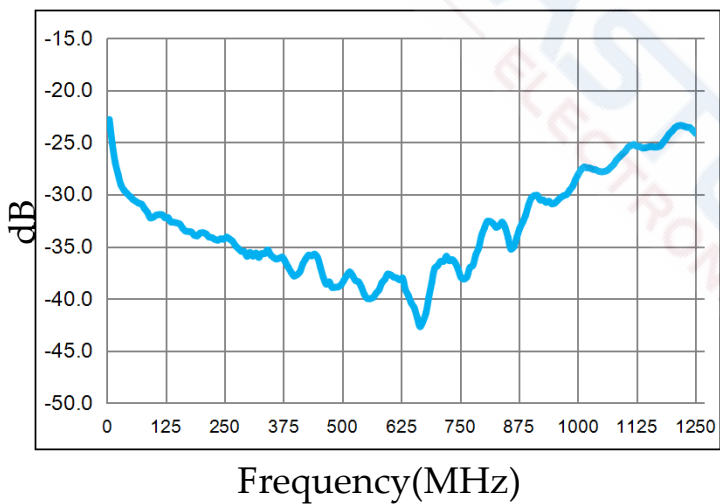

Output Return Loss (Pin6)

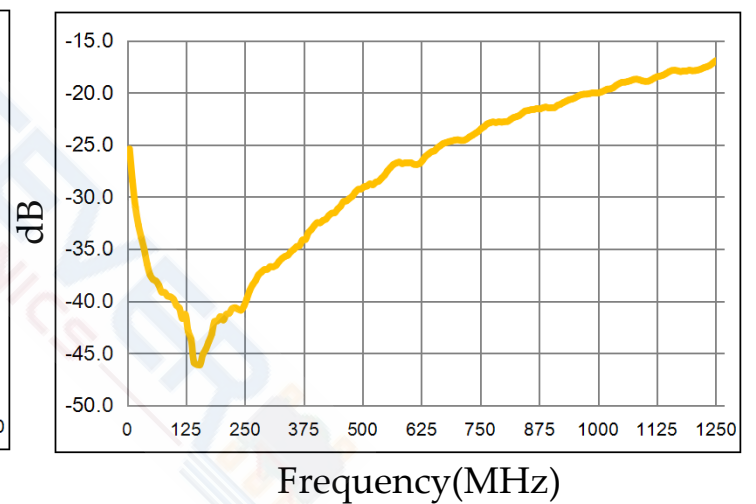

Coupling Return Loss (Pin6)

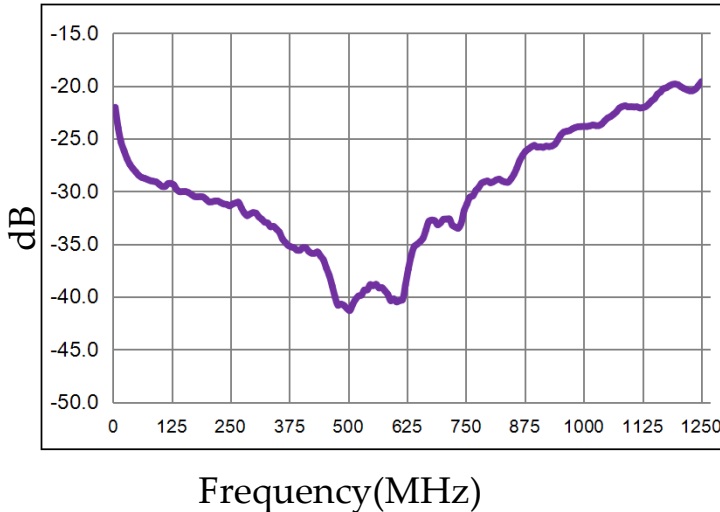

Isolation (Pin1-4)

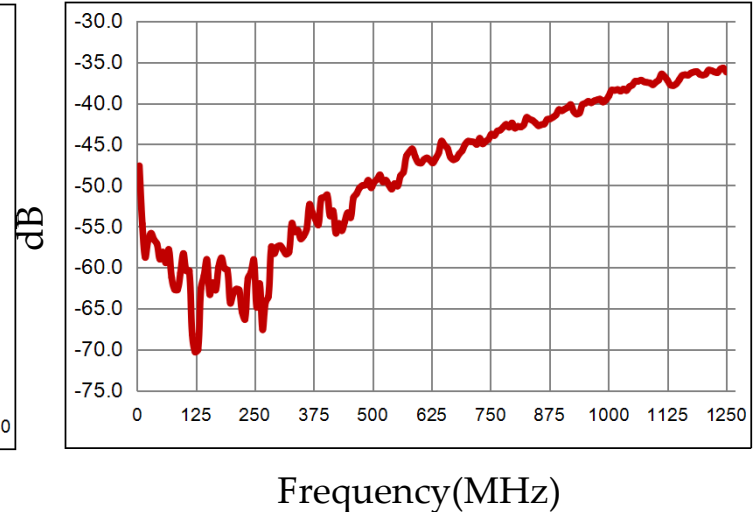

Recommended Soldering Temperature Graph:

Typical RoHS Reflow Profile

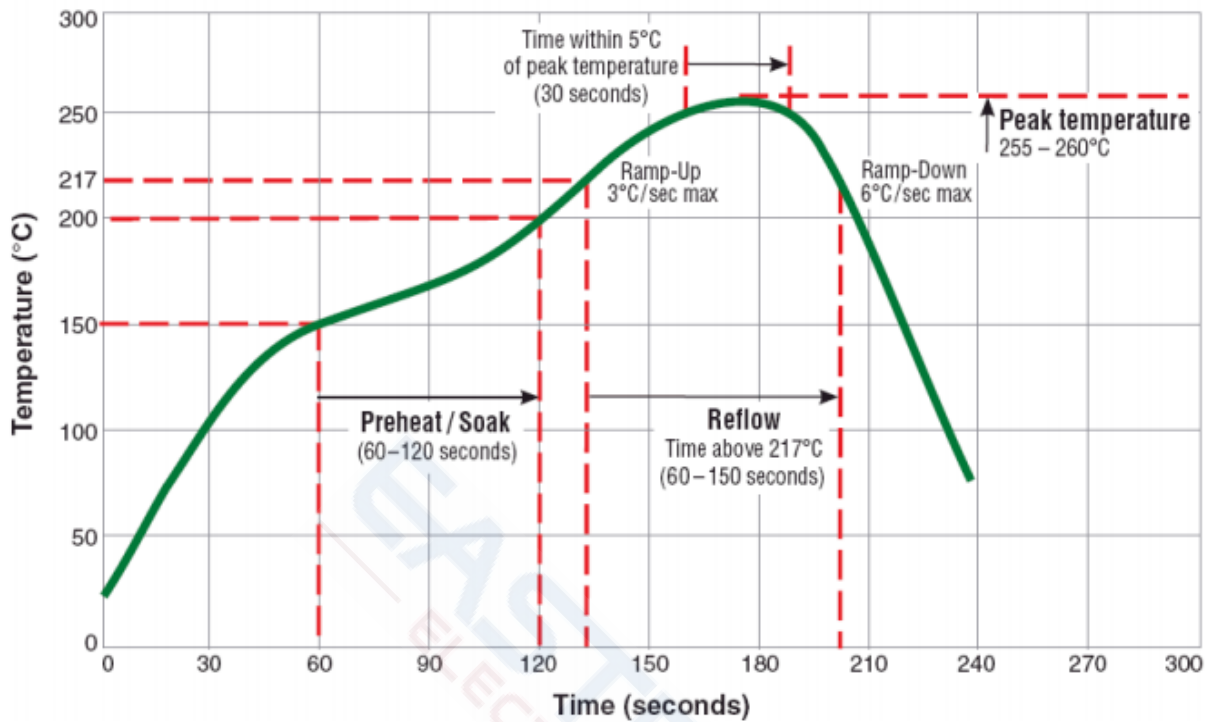

Packaging Dimension For Caeier Tape(UNIT:mm):

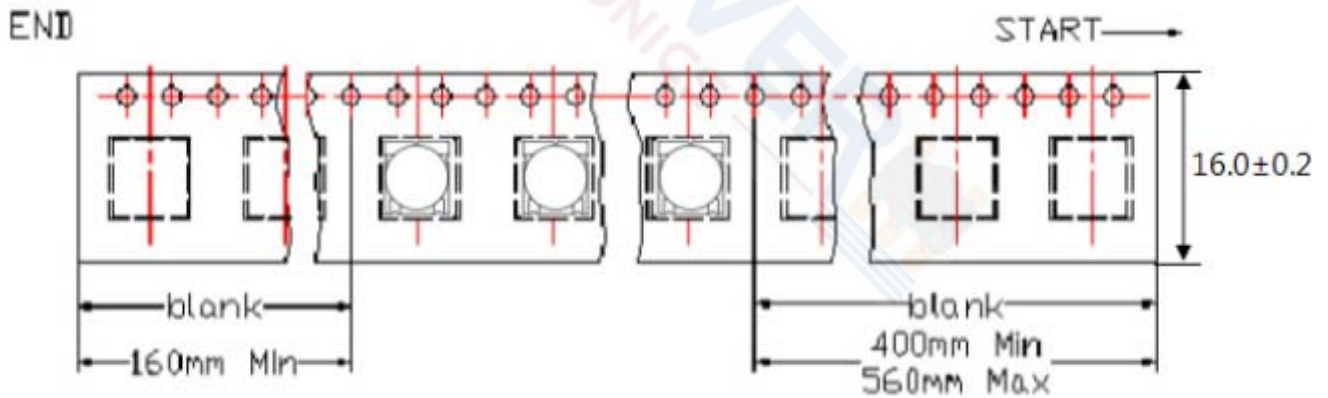

<b>QUANTITY</b>
1500PCS/Reel
3Reels/Middle Carton Middle Carton:
4 Middle Cartons/Big Carton
18000PCS/ Big Carton

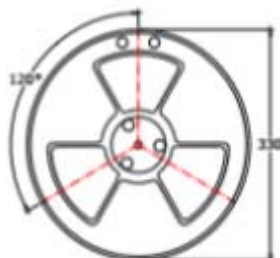

SPEC	8	12	16	24
DIM A±0.1	8.5	12.5	16.5	24.5
DIM B±0.1	2.3	2.3	2.3	2.3
DIM C±0.1	100	100	100	100

